

# STRUJNI KRUG

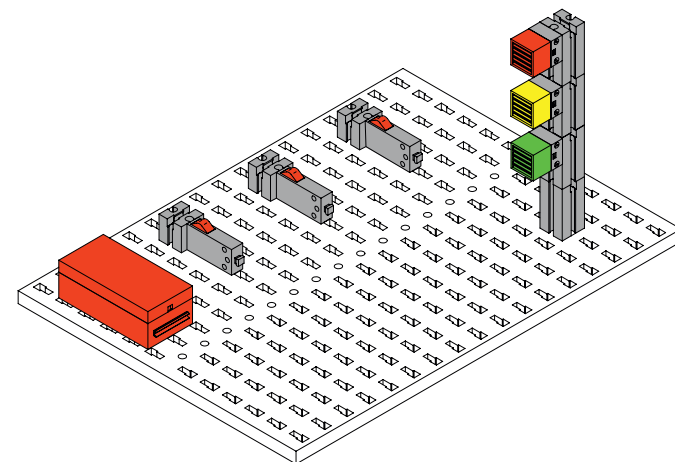

STRUJNI KRUG



40000 Čakovec,  
Travnicka 18  
tel: 040/364-445  
fax: 040/364-230

WEB: <http://www.didakta.hr>  
E-mail: [didakta@ck.t-com.hr](mailto:didakta@ck.t-com.hr)







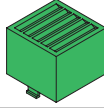
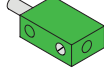
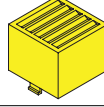
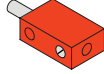

fischertechnik 

17

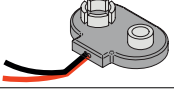
17

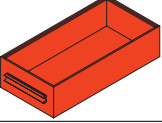
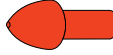
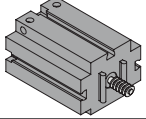
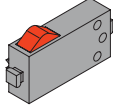
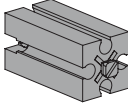
# STRUJNI KRUG

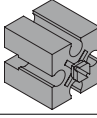
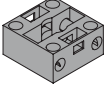
# ELEMENTI

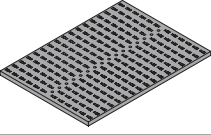
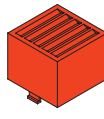
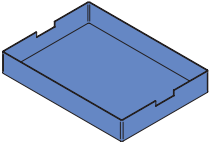
1		31360	1		35084
1		31336	1		35085
1		31337	10		35969
1		32233	1		36559
1		32263	1		37681
1		32293	3		37783
4		32879	3		37869
3		32881	3		38216
1		32882			
1		32958	1		32985
1		35079	1		36360

VJEŽBA 3 - spajanje žica

način A

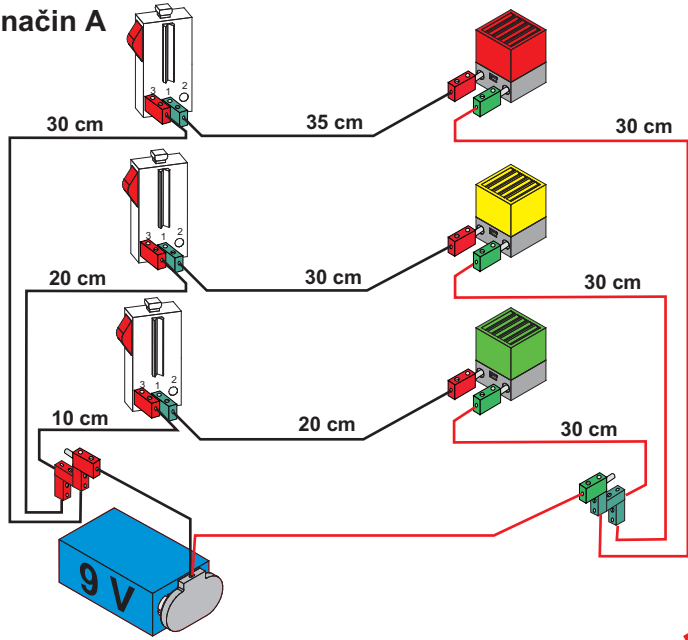

- 14  
x 10 - 31336
- x 10 - 31337
- x 1 - 31360

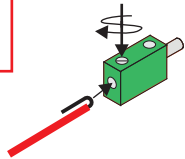

način B

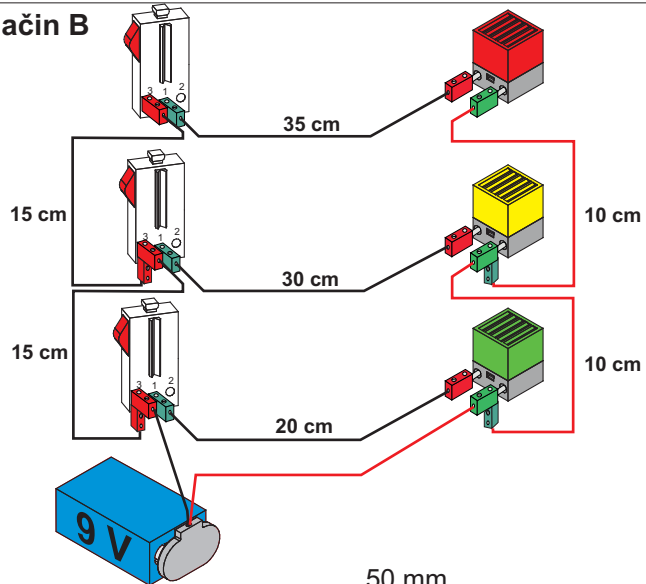

- 15  
x 8 - 31336
- x 8 - 31337
- x 1 - 31360

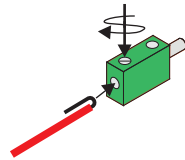

50 mm

100 mm

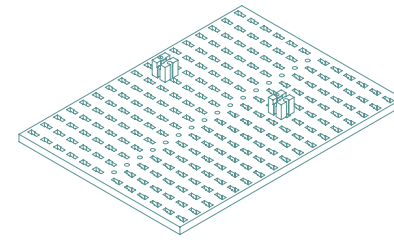

- 1  
x 2 - 32881

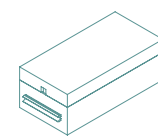
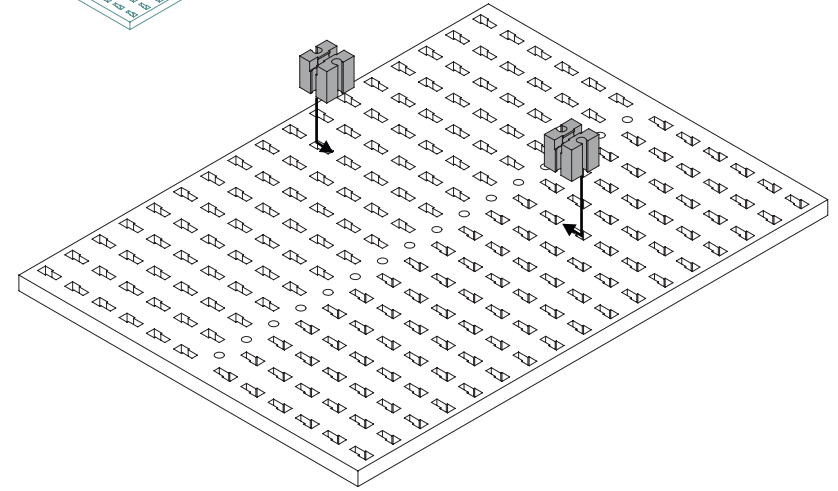

SKLOP 1

NAPAJANJE - baterijski uložak 9V

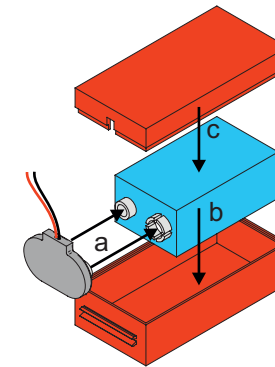

- 2  
x 1 - 32958
  - x 1 - 32233
  - x 1 - 32263
- bat. uložak 9V

2

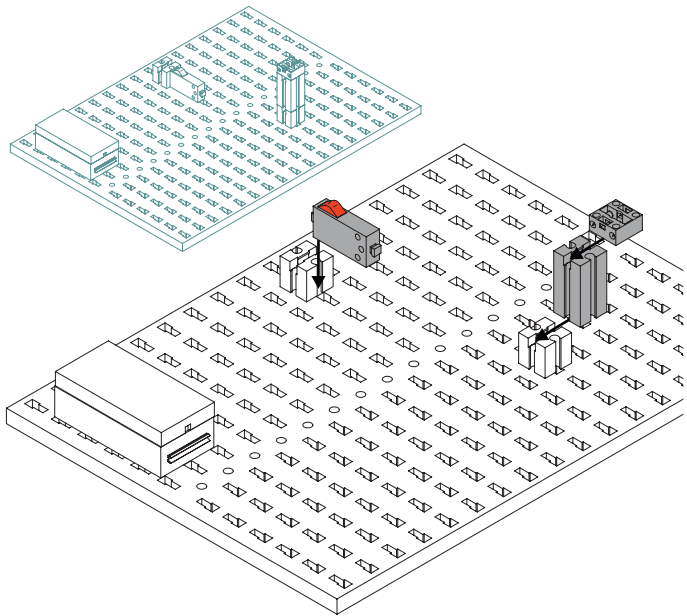

- 3**  
x 1 - 37783
- 1**  
x 1 - 38216
- 2**  
x 1 - 32879
- 1**  
x 1 - sklop 1

7

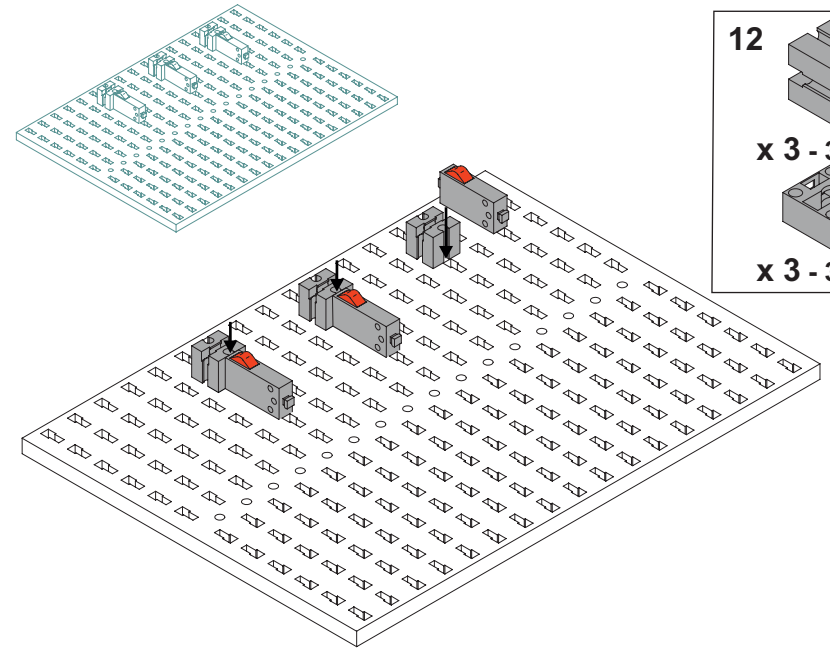

- 12**  
x 3 - 32881
- 3**  
x 3 - 38216

**VJEŽBA 1 - model**

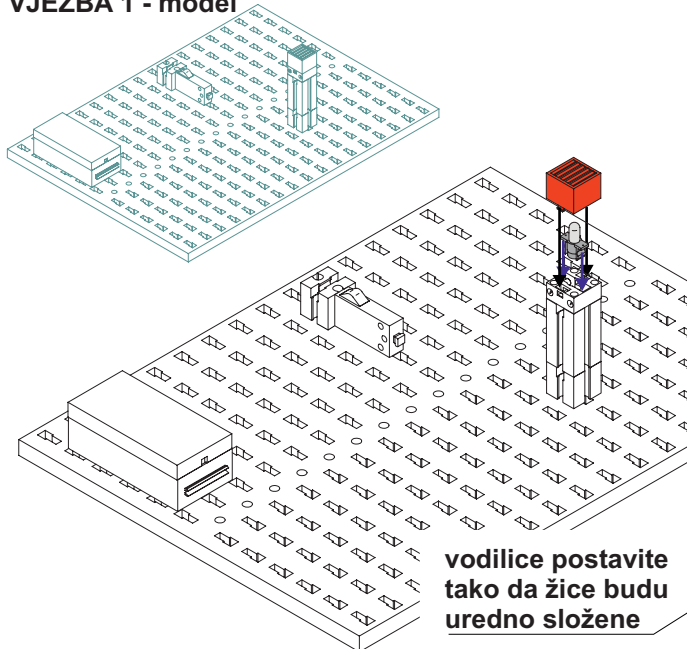

- 4**  
x 1 - 37869
- 1**  
x 1 - 35079

- 1**  
x 1 - 35969

vodilice postavite tako da žice budu uredno složene

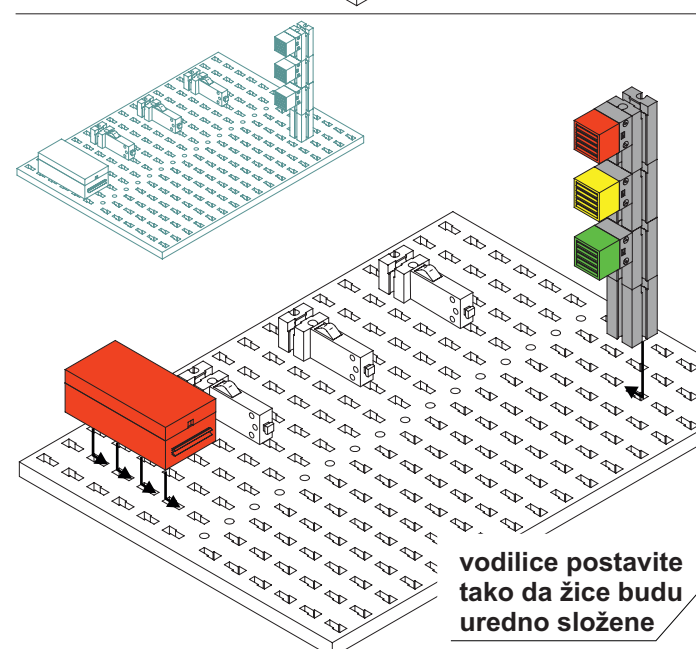

- 13**  
x 1 - sklop 2
- 1**  
x 1 - sklop 1
- 10**  
x 10 - 35969

vodilice postavite tako da žice budu uredno složene

6

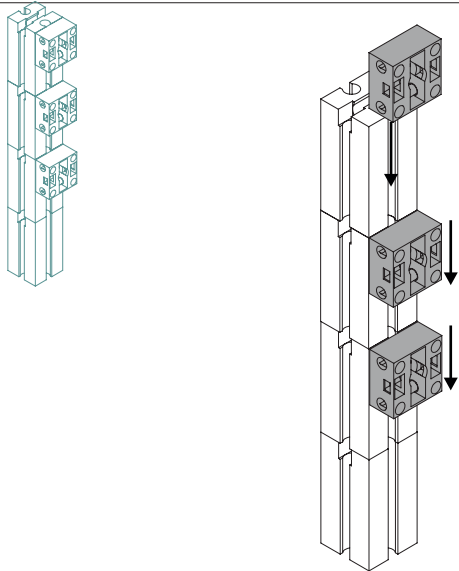

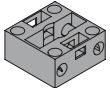

10   
x 3 - 38216

3

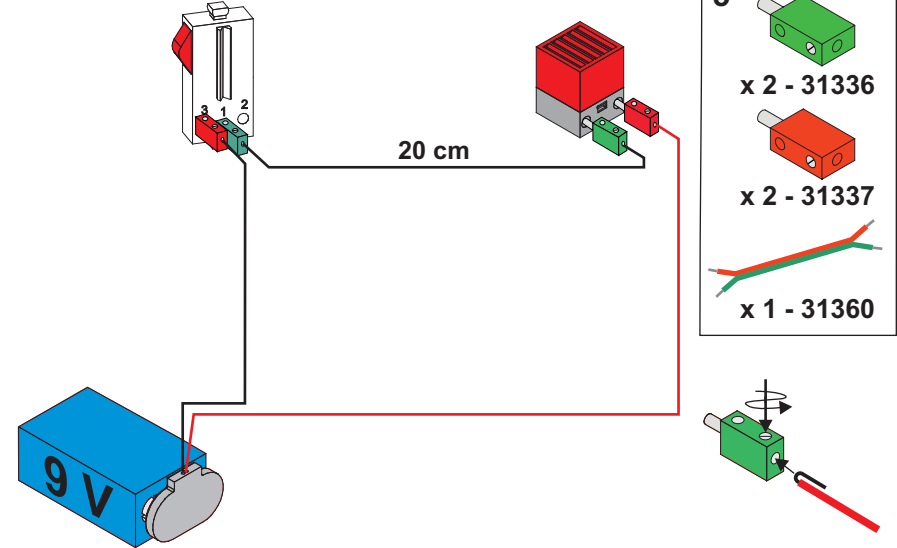
### VJEŽBA 1 - spajanje žica

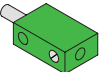
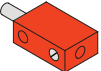

5   
x 2 - 31336  
  
x 2 - 31337  
  
x 1 - 31360

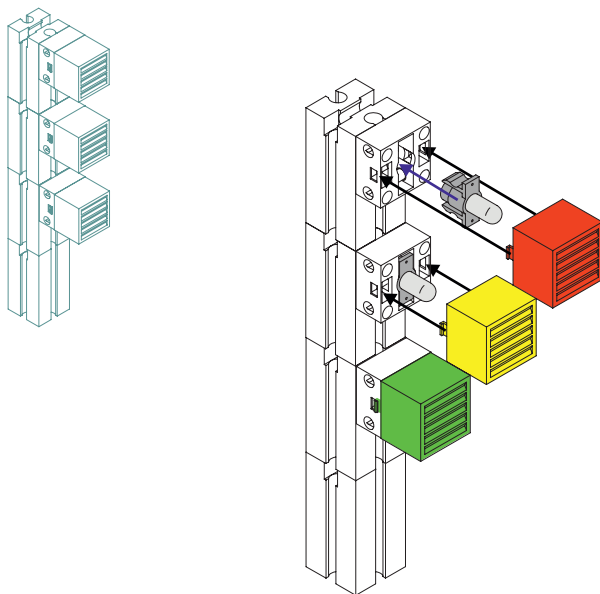
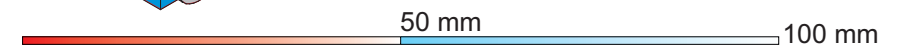

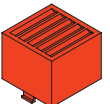
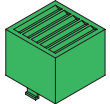
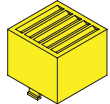
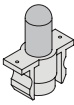
11   
x 1 - 35079  
  
x 1 - 35084  
  
x 1 - 35085  
  
x 3 - 37869

### SPAJANJE TIPKALA

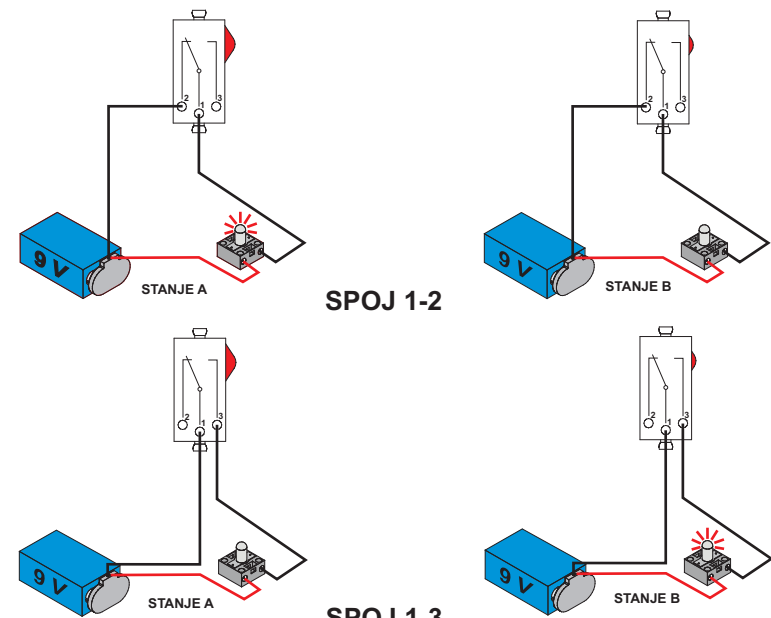

4

VJEŽBA 2 - model

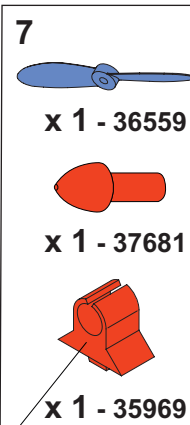
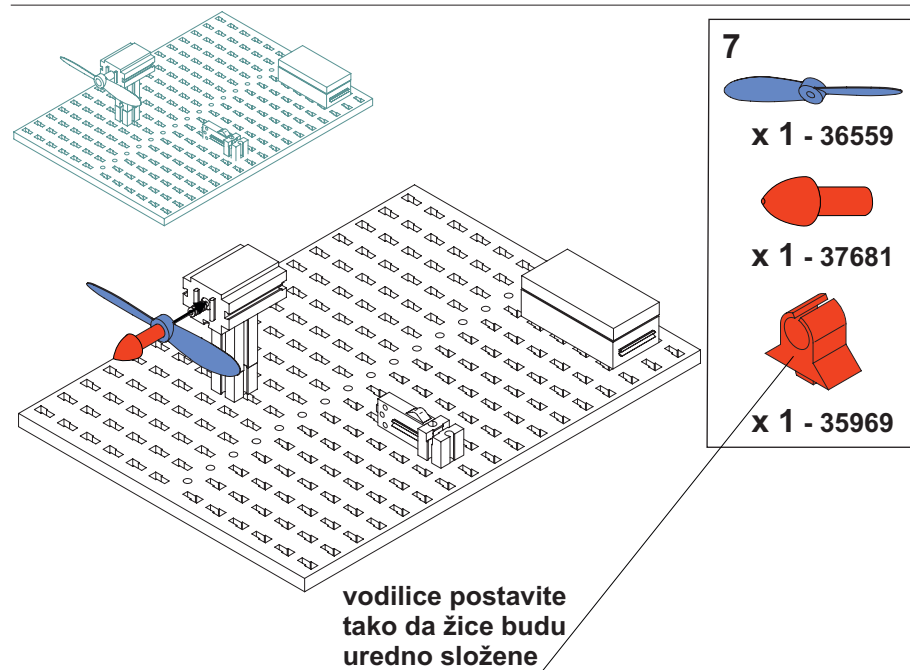
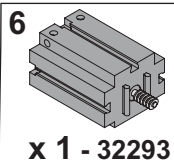
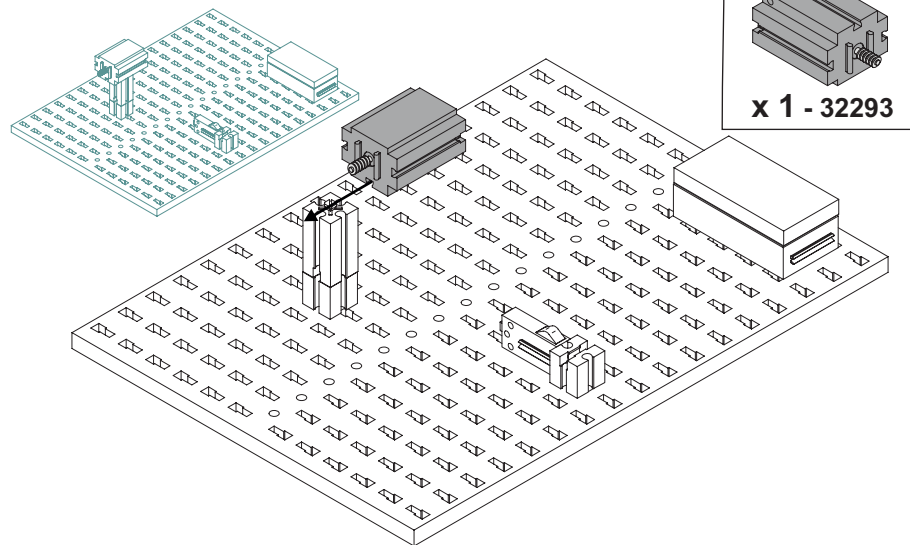

vodilice postavite tako da žice budu uredno složene

5

VJEŽBA 2 - spajanje žica

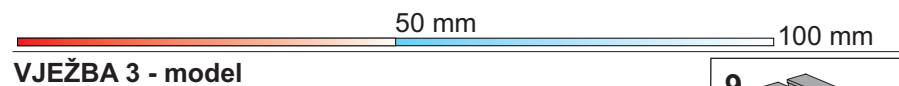
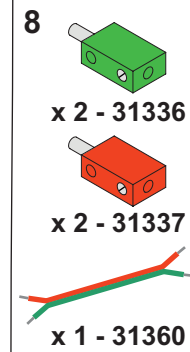
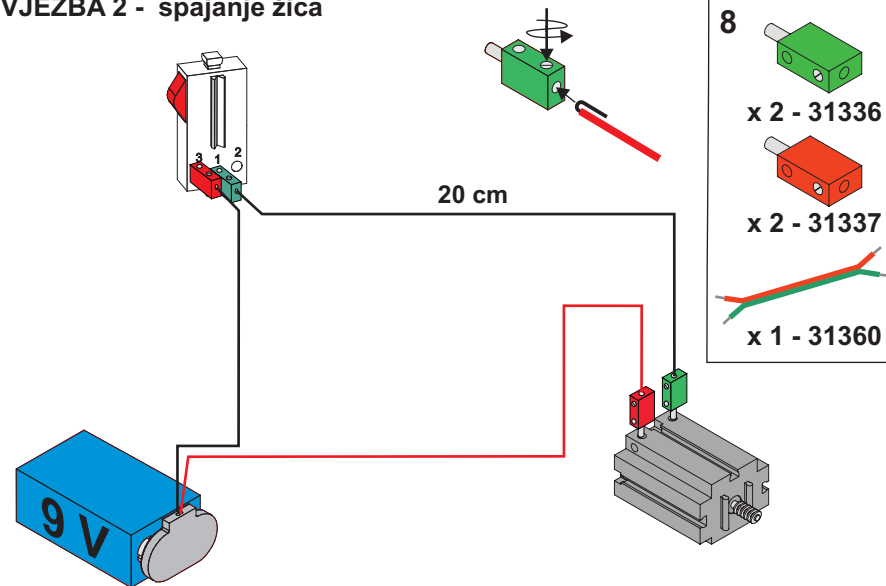

VJEŽBA 3 - model

